



World Registrar Group  
ISO 9001  
ISO 14001  
ISO 45001

# KATALOG

## MERNO RAZVODNIH ORMANA SERIJE

- MRO • MRO-A • MOMM
- MRO-I • MRO-P
- KABLOVSKIH PRIKLJUČNIH  
KUTIJA KPK

**2024**





# METALNI MERNI RAZVODNI ORMANI

## TEHNIČKI OPIS



World Registrar Group  
ISO 9001  
ISO 14001  
ISO 45001



Tipski ugradni ormani se proizvode u dve serije: serija MRO i MRO-A.

Ugrađuju se u zid ili fiksirani za zid, pojedinačno ili linijski, u kombinaciji sa ostalim ormanima iz iste serije, spajanjem bočnih stranica skrivenom vijčanom vezom. Sastoje se od kućišta, vrata i (opciono) postolja.

Kućište je izrađeno od dekapiranog hladno valjanog čeličnog lima (DC01) debljine 1.2mm. Rešetkasta konstrukcija rama kućišta ukurucena distantnim profilima spojenim zavarivanjem MAG postupkom.

Zadnja stranica potpuno zatvorena. Bočne stranice sa otvorima za prolaz kablova i otvorima za fiksiranje sa narednim ormanom. Gornja strana MRO sa otvorima za prolaz kablova iz razvodnog prostora i (opciono) otvorima za prolaz kablova za tarifu. Otvor na kućištu za vrata formiran sa okapnicom visine min 20mm.

Unutrašnjost formirana sa pomoćnom rešetkastom podkonstrukcijom, namenjenoj ugradnji elektro-opreme i razvodu kablova. Šarniri izrađeni od ZAMAK-5 legure, skriveno postavljeni vijčanom vezom, demontažni, bez potrebe za naknadnim održavanjem, od renomiranog proizvođača.

Vrata su izrađena od dekapiranog hladno valjanog čeličnog lima (DC01) debljine 1.2mm. Izvedba sa desnim otvaranjem, maksimalnim uglom otvaranja do 120°.

Ormani serije MRO" se zabavljaju sa dve brave i ključem, opciono drugačije zabavljanje na zahtev naručioca.

Ormani serije MRO-A se isporučuju sa jednom EDB bravicom a drugom sa T ključem.

Ormani iz serije MRO su sa ugrađenim plastičnim prozorima za nadgledanje displeja ugrađene elektro opreme a ormani serije MRO-A su bez prozora.

Ploče brojila kod ormara serije MRO se izrađuju od hladno valjanog čeličnog lima (DC01) ili ABS-a V-0 a kod ormara serije MRO-A od hladno valjanog čeličnog lima (DC01).

Bočne stranice izrađene od dekapiranog hladno valjanog čeličnog lima (DC01) debljine 1.2mm. Otvori za fiksiranje sa susednim ormanom postavljeni celom visinom ormara. U donjoj zoni pripremljeni otvori Ø70 i Ø28 za prolaz kablova, na obe bočne stranice.

Postolje (opciona izrada) je izrađeno od dekapiranog hladno valjanog čeličnog lima (DC01) debljine 2.0mm. Zavarena jednodelnja konstrukcija visine 100mm sa četiri otvora Ø9 za ankerisanje na podlogu.

Antikorozivna zaštita kućišta i vrata obavljena postupkom pasivnog fosfatiziranja i elektro-statičke plastifikacije strukturnim poliester prahom minimalne debljine nanosa 80-100µm, UV stabilnim na spoljašnje uslove, pečenjem u peći na temperaturi od 180°C u standardnoj nijansi boje prema RAL 7035 (svetlo siva).

Postolje ofarbano u standardnoj nijansi boje prema RAL 7035.



World Registrar Group  
ISO 9001  
ISO 14001  
ISO 45001

**MRO-A15**

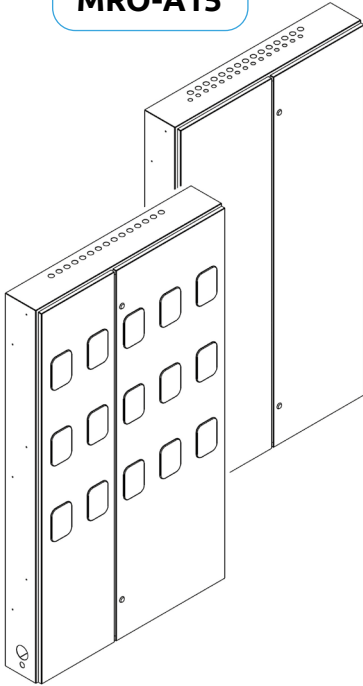

**MRO-A12**

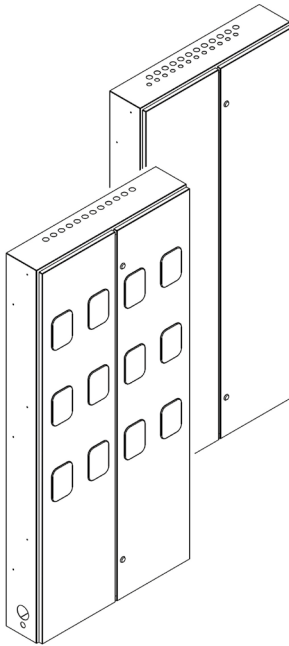

**MRO-A9**

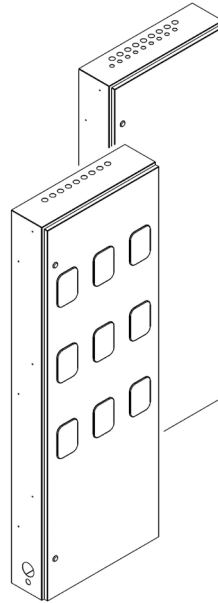

**MRO-A6**

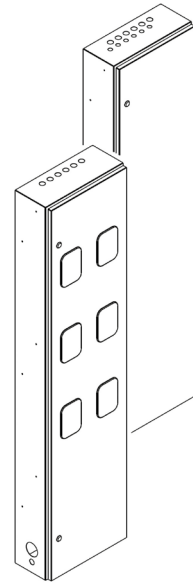

**MRO-15**

**MRO-12**

**MRO-9**

**MRO-6**

**MRO-A4**

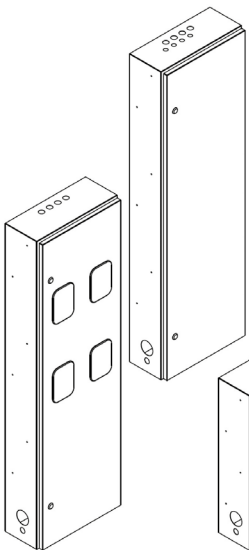

**MRO-A3**

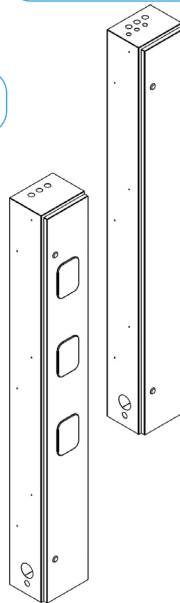

**MRO-A2V**

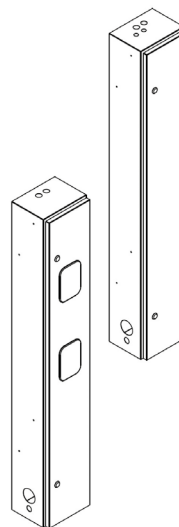

**MRO-A4H**

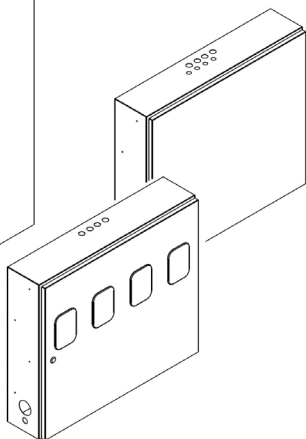

**MRO-A2**

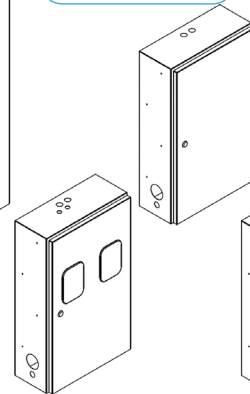

**MRO-A1**

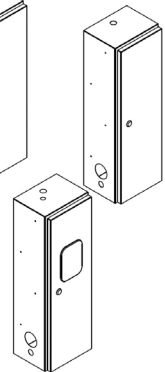

**MRO-4**

**MRO-4H**

**MRO-3**

**MRO-2V**

**MRO-2**

**MRO-1**



# METALNI MERNI RAZVODNI ORMANI

## SPECIFIKACIJA SERIJE MRO ORMANA



World Registrar Group  
ISO 9001  
ISO 14001  
ISO 45001

| oznaka ormara | širina (mm) | visina (mm) | dubina (mm) | broj bravica | broj šarnira | Art. No  |
|---------------|-------------|-------------|-------------|--------------|--------------|----------|
| MRO-15        | 1135        | 1970        | 215         | 2            | 6            | 19-19822 |
| MRO-12        | 915         | 1970        |             | 2            | 6            | 19-20004 |
| MRO-9         | 695         | 1970        |             | 2            | 3            | 19-19839 |
| MRO-6         | 475         | 1970        |             | 2            | 3            | 19-20005 |
| MRO-4         | 475         | 1570        |             | 2            | 3            | 19-20518 |
| MRO-4H        | 915         | 905         |             | 1            | 2            | 19-20941 |
| MRO-3         | 255         | 1970        |             | 2            | 2            | 19-20006 |
| MRO-2         | 475         | 855         |             | 1            | 2            | 19-20685 |
| MRO-2V        | 255         | 1255        |             | 2            | 2            | 19-20942 |
| MRO-1         | 255         | 855         |             | 1            | 2            | 19-20592 |

### DIMENZIJE MRO-15

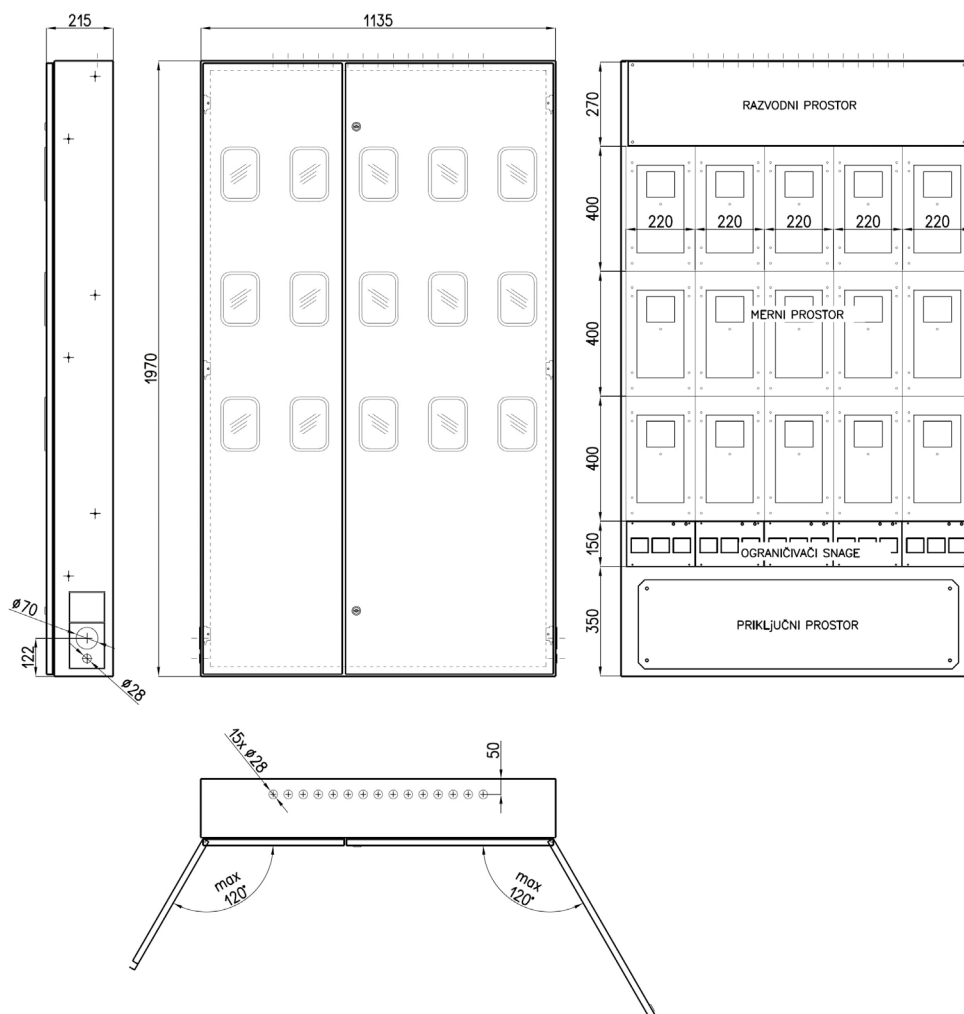



# METALNI MERNI RAZVODNI ORMANI

## DIMENZIJE MRO-12

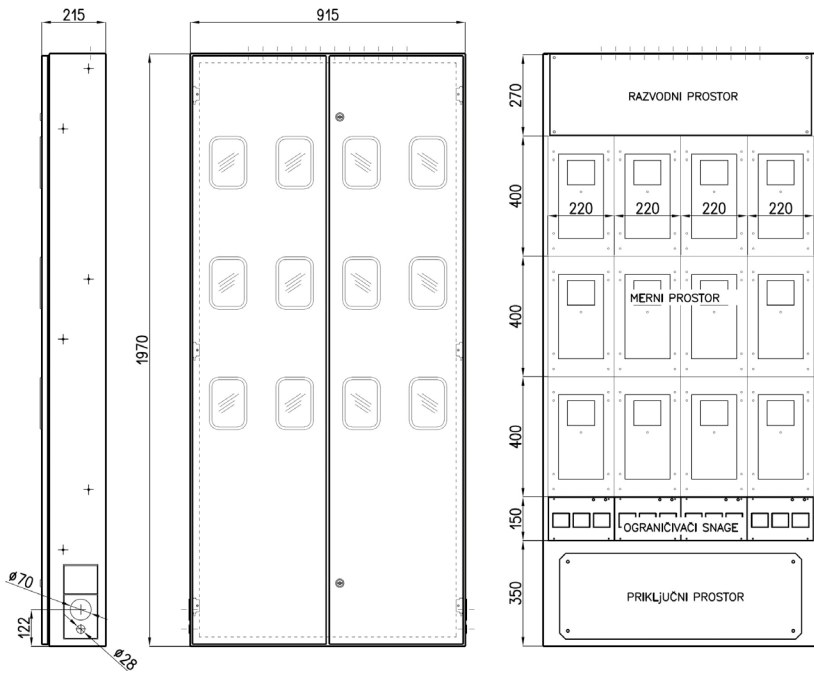

World Registrar Group  
ISO 9001  
ISO 14001  
ISO 45001

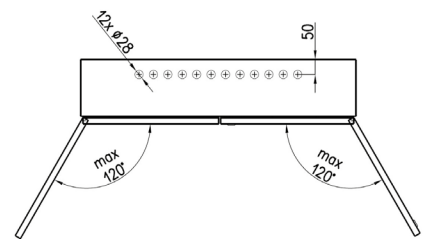

## DIMENZIJE MRO-9

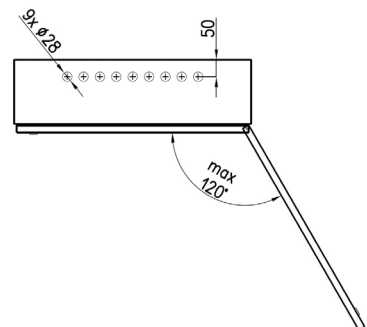
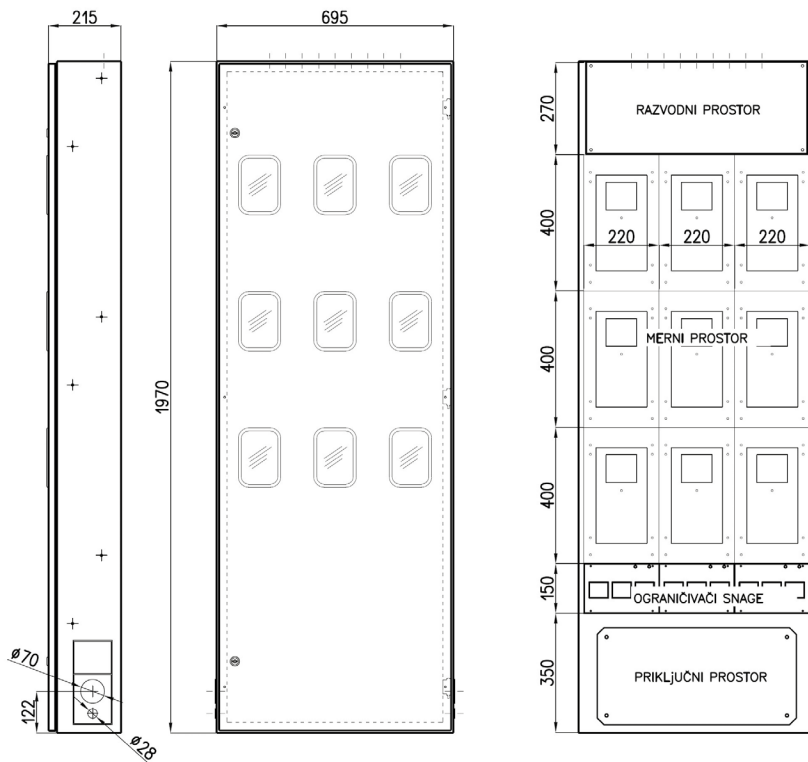



# METALNI MERNI RAZVODNI ORMANI

## DIMENZIJE MRO-6



World Registrar Group  
ISO 9001  
ISO 14001  
ISO 45001

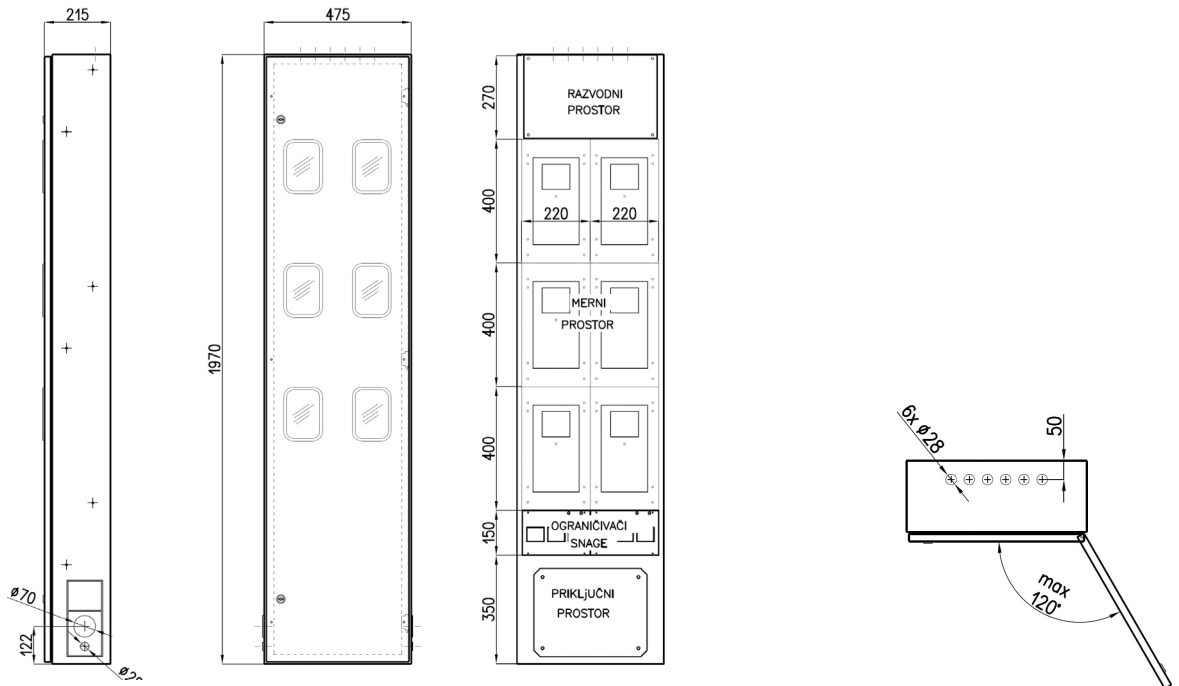

## DIMENZIJE MRO-4

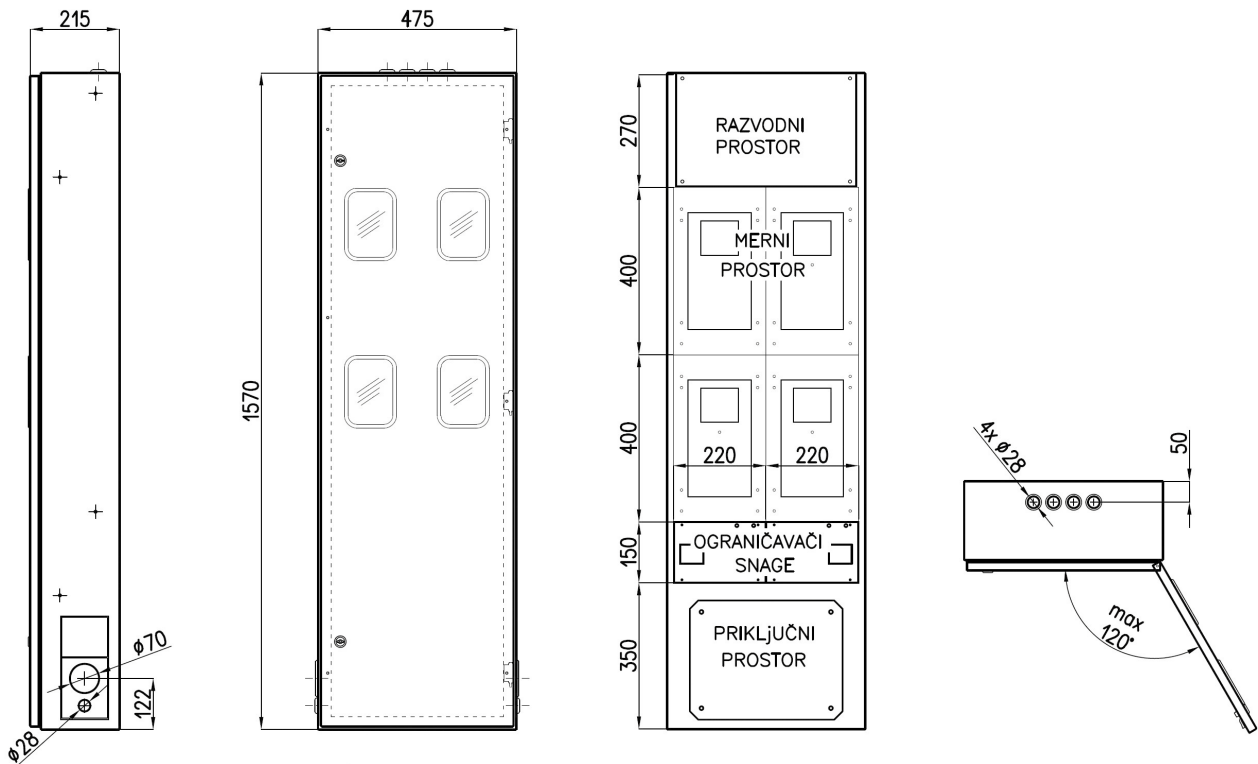



# METALNI MERNI RAZVODNI ORMANI

## DIMENZIJE MRO-4H



World Registrar Group  
ISO 9001  
ISO 14001  
ISO 45001

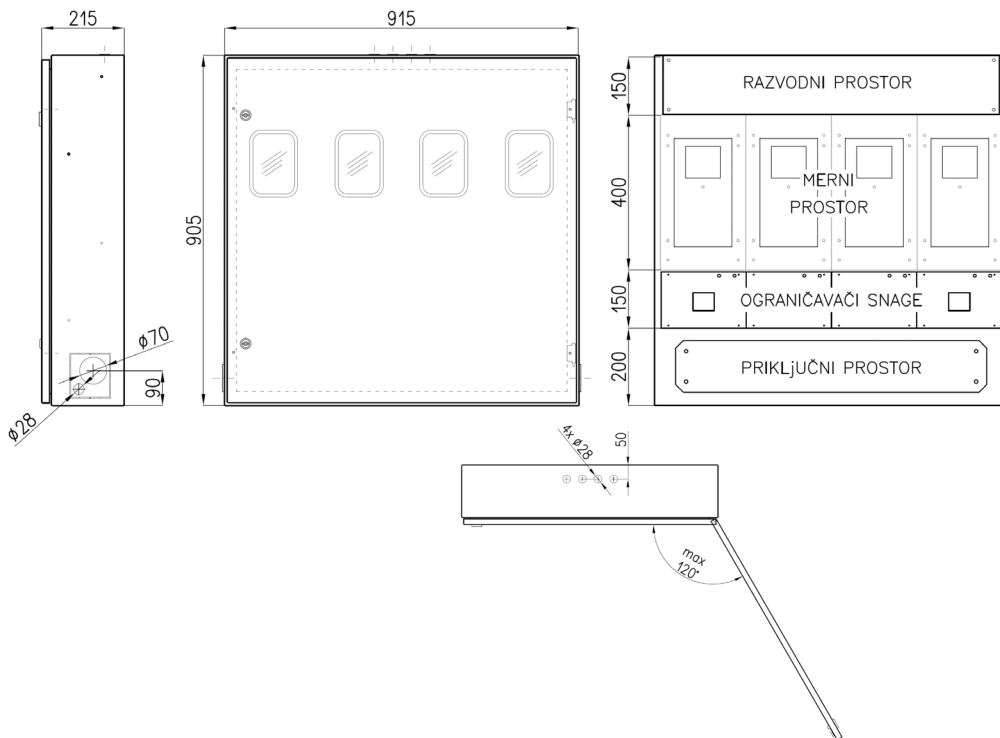

## DIMENZIJE MRO-3

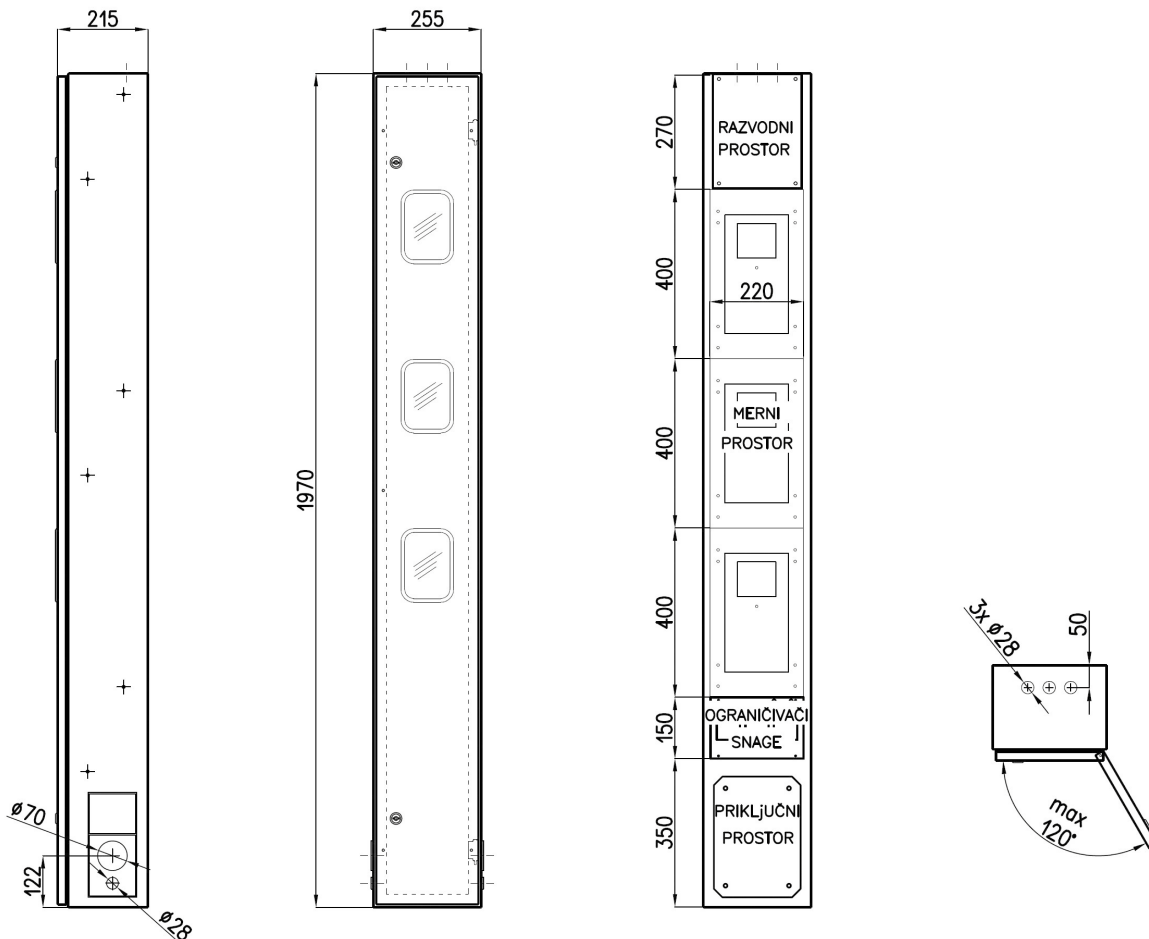



# METALNI MERNI RAZVODNI ORMANI

## DIMENZIJE MRO-2V



World Registrar Group  
ISO 9001  
ISO 14001  
ISO 45001

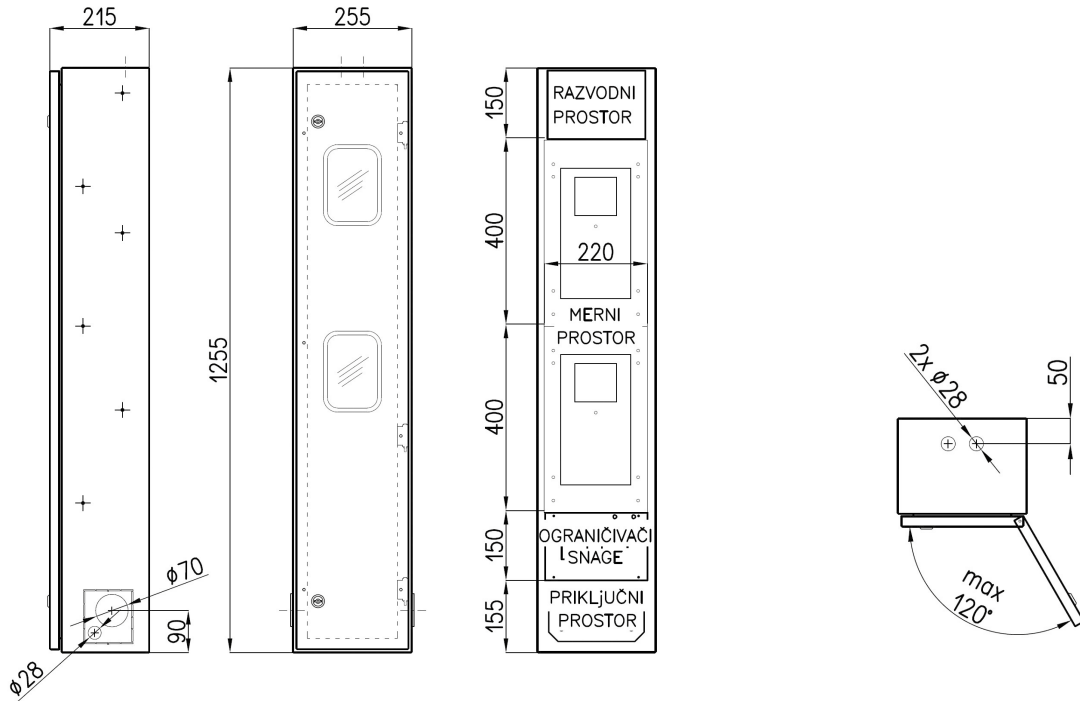

## DIMENZIJE MRO-2

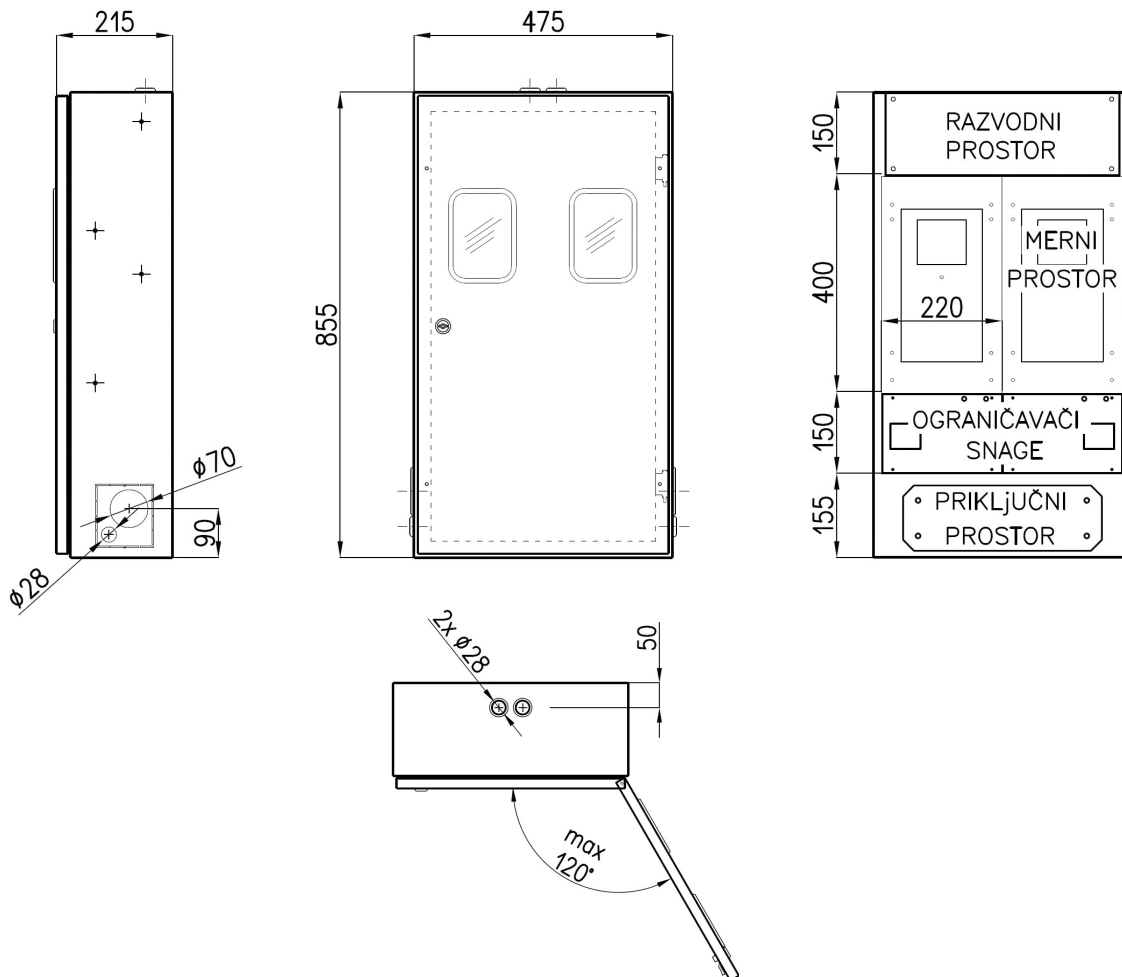



## DIMENZIJE MRO-1



World Registrar Group  
ISO 9001  
ISO 14001  
ISO 45001

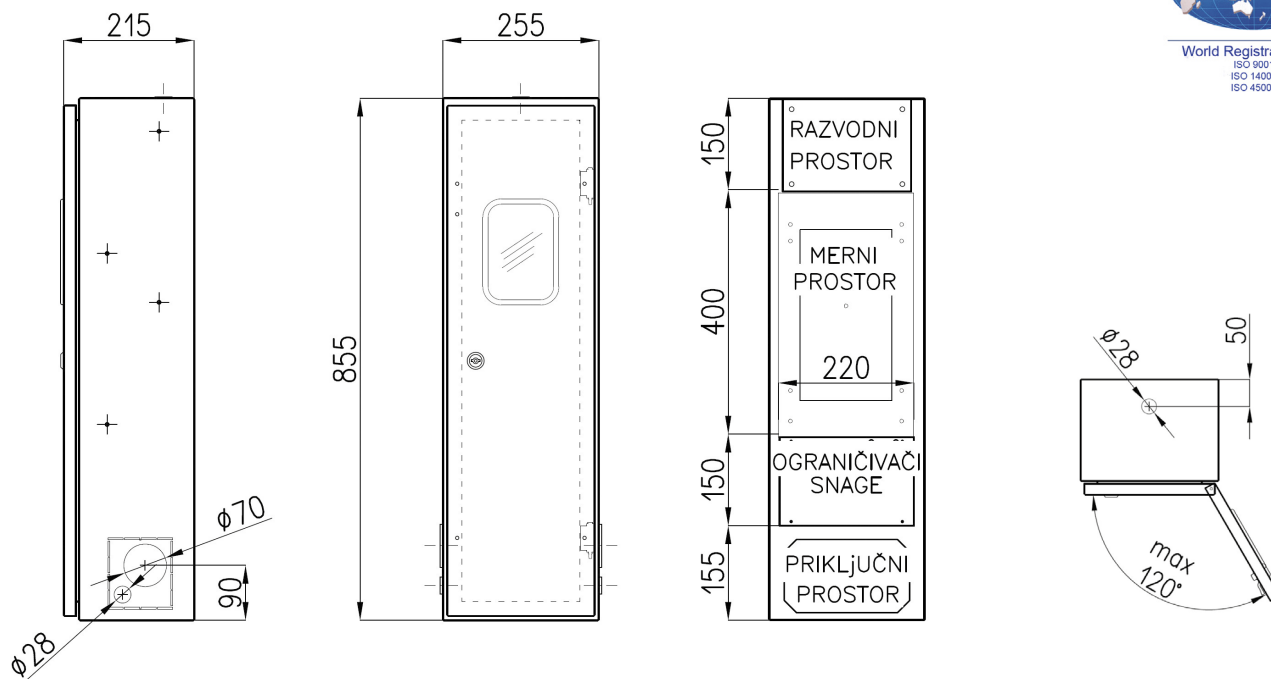

## SPECIFIKACIJA serije MRO-A ORMANA

| oznaka ormara | širina (mm) | visina (mm) | dubina (mm) | broj bravica | broj šarnira | Art. No  |
|---------------|-------------|-------------|-------------|--------------|--------------|----------|
| MRO-A15       | 1135        | 1970        | 215         | 2            | 6            | 19-20758 |
| MRO-A12       | 915         | 1970        |             | 2            | 6            | 19-20759 |
| MRO-A9        | 695         | 1970        |             | 2            | 3            | 19-20760 |
| MRO-A6        | 475         | 1970        |             | 2            | 3            | 19-20761 |
| MRO-A4        | 475         | 1570        |             | 2            | 3            | 19-20762 |
| MRO-A4H       | 915         | 905         |             | 1            | 2            | 19-20943 |
| MRO-A3        | 255         | 1970        |             | 2            | 2            | 19-20763 |
| MRO-A2        | 475         | 855         |             | 1            | 2            | 19-20764 |
| MRO-A2V       | 255         | 1255        |             | 2            | 2            | 19-20944 |
| MRO-A1        | 255         | 855         |             | 1            | 2            | 19-20765 |



# METALNI MERNI RAZVODNI ORMANI

## DIMENZIJE MRO-A15



World Registrar Group  
ISO 9001  
ISO 14001  
ISO 45001

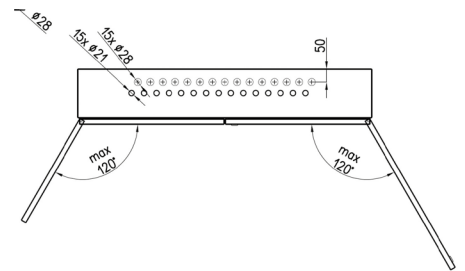
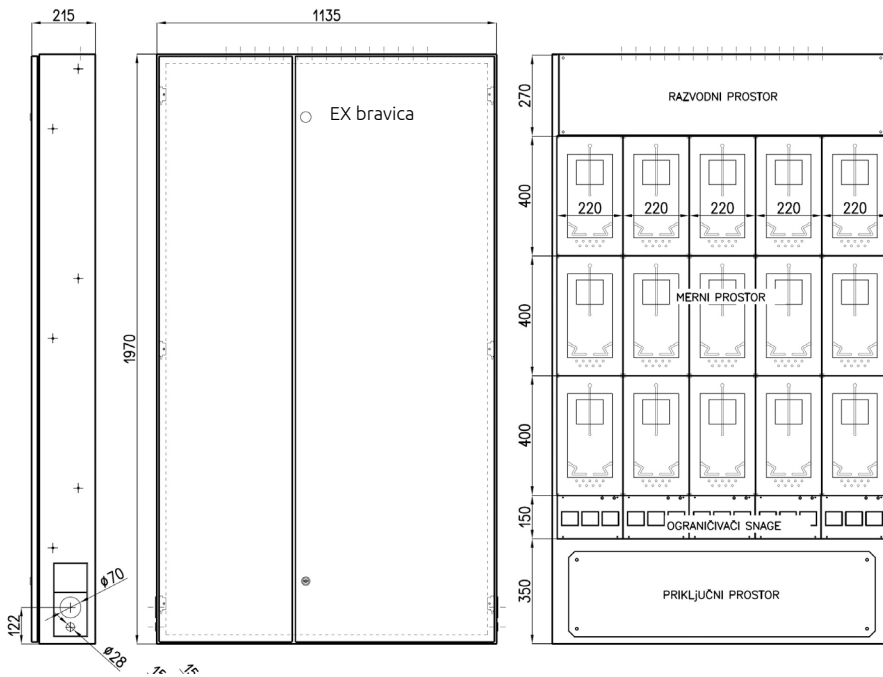

## DIMENZIJE MRO-A12

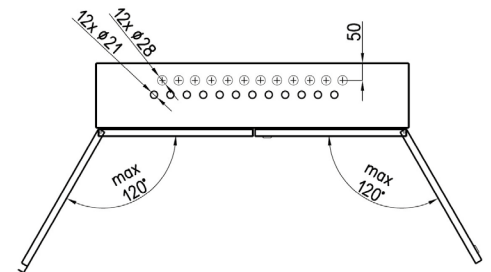
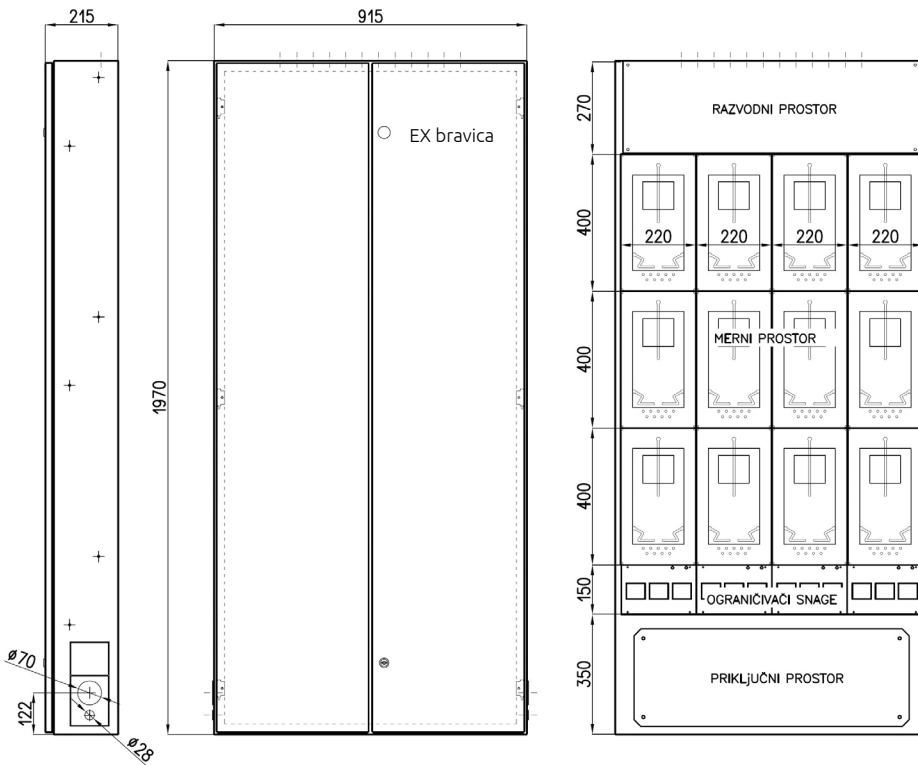

## DIMENZIJE MRO-A9



World Registrar Group  
ISO 9001  
ISO 14001  
ISO 45001

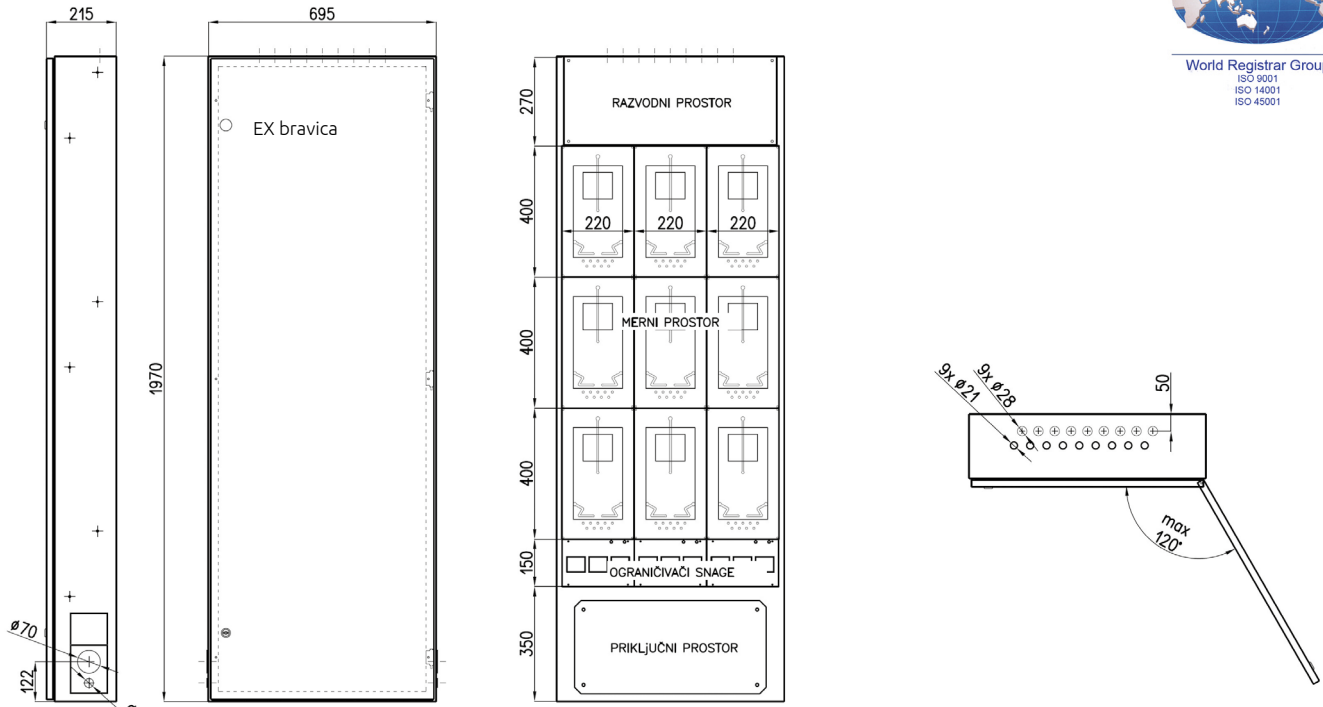

## DIMENZIJE MRO-A6

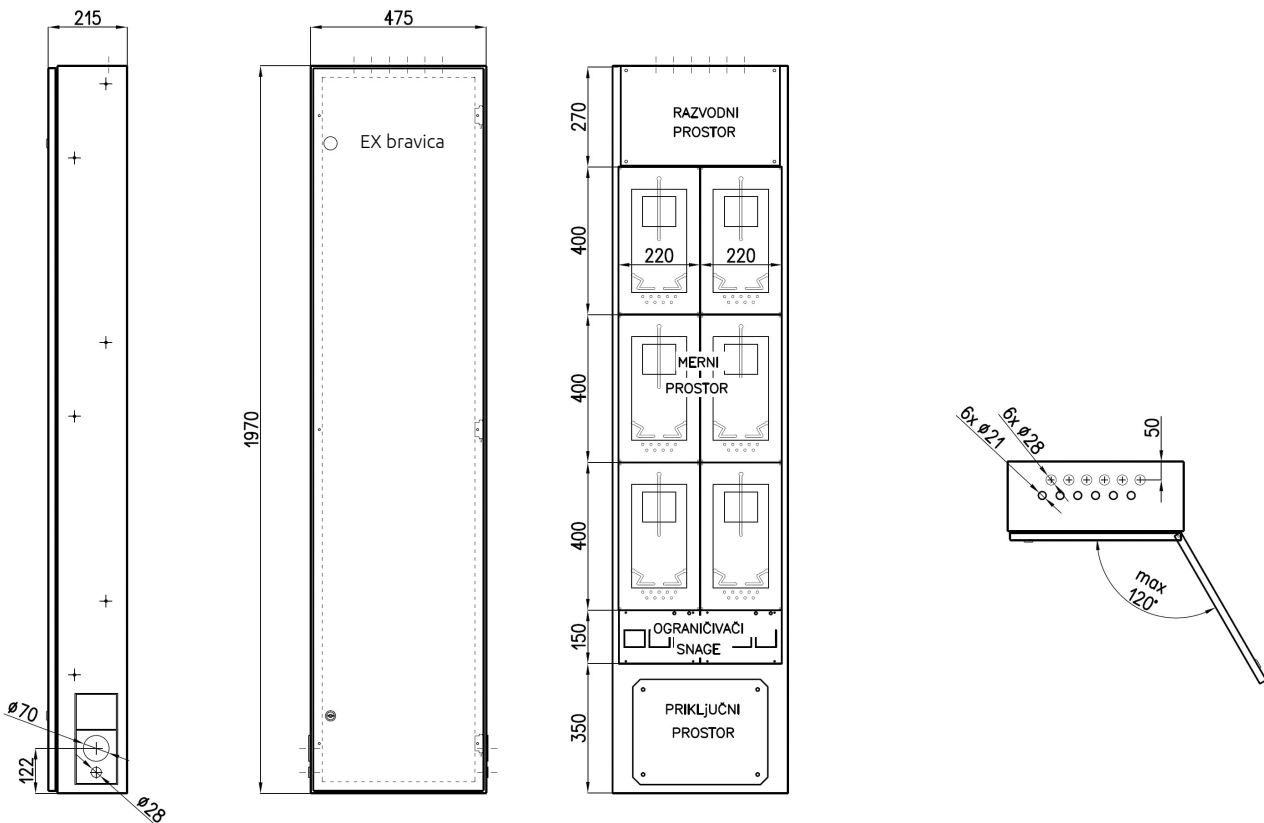



# METALNI MERNI RAZVODNI ORMANI

## DIMENZIJE MRO-A4



World Registrar Group  
ISO 9001  
ISO 14001  
ISO 45001

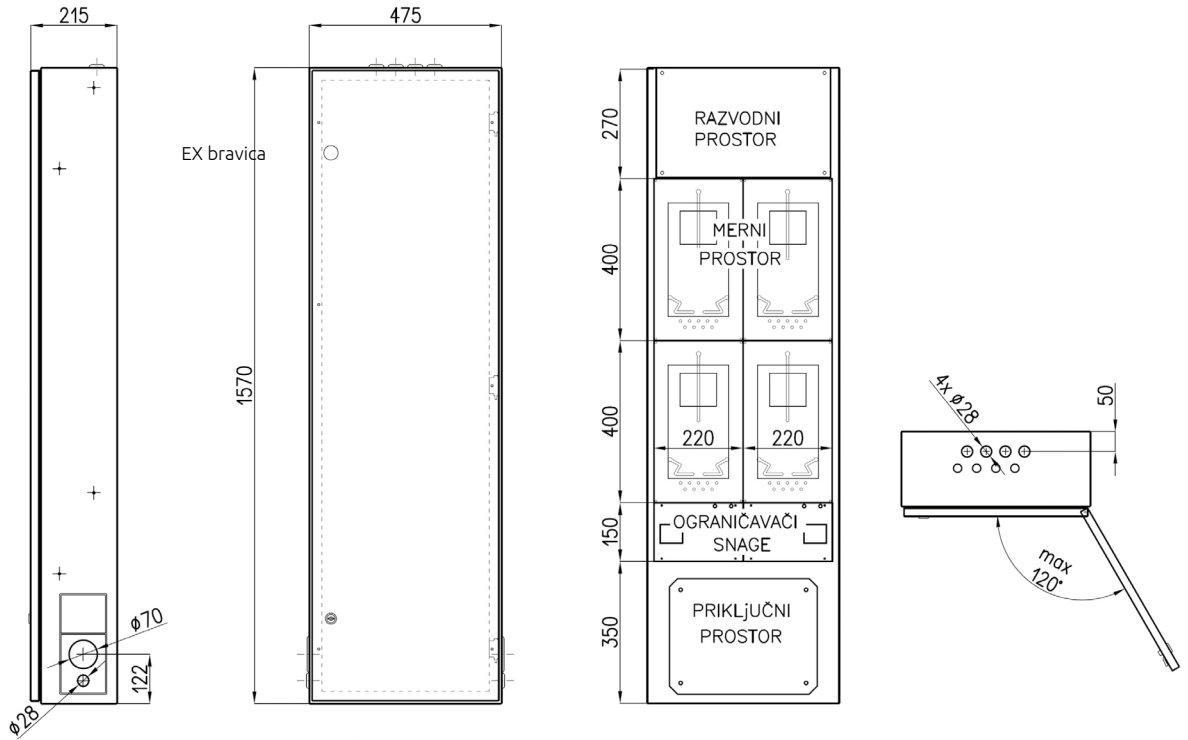

## DIMENZIJE MRO-A4H

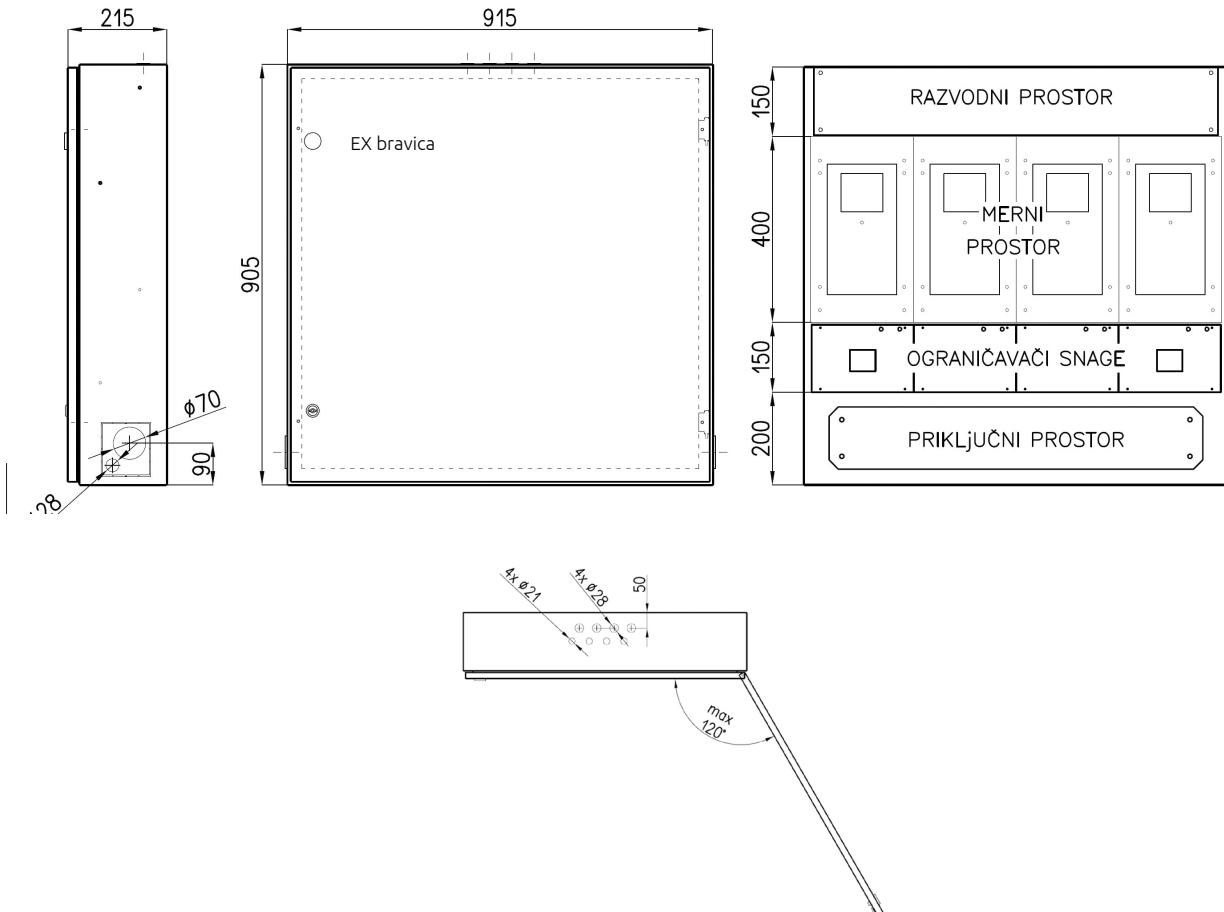

## DIMENZIJE MRO-A3



World Registrar Group  
ISO 9001  
ISO 14001  
ISO 45001

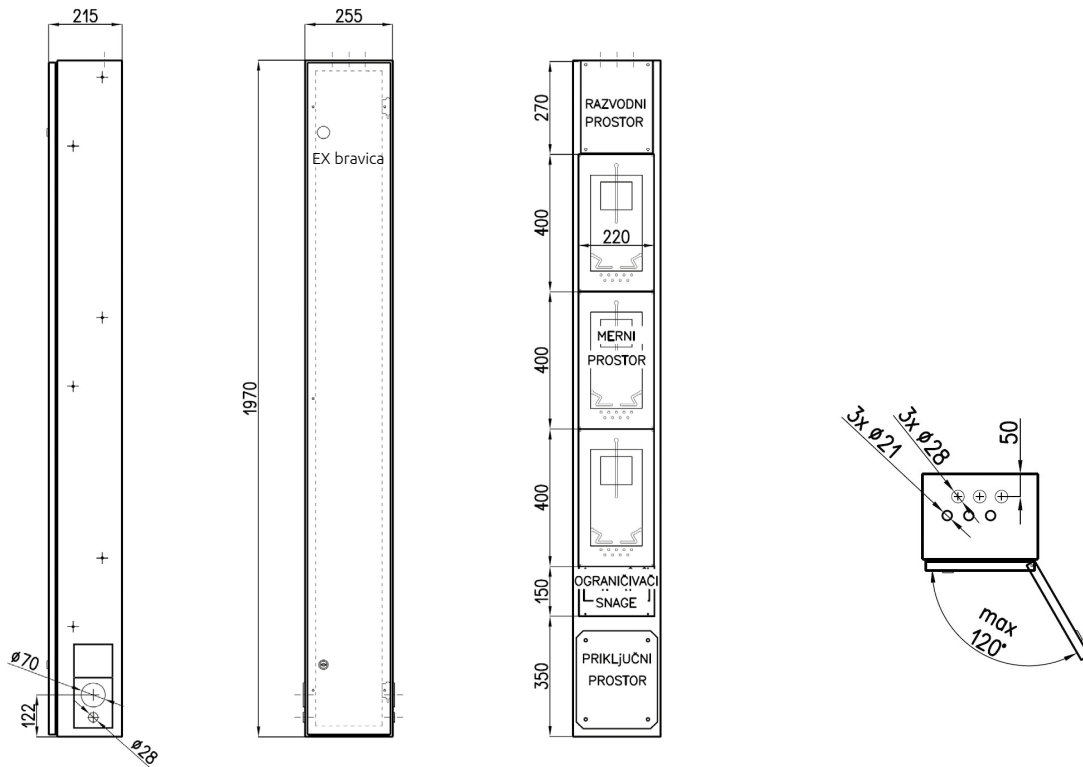

## DIMENZIJE MRO-A2

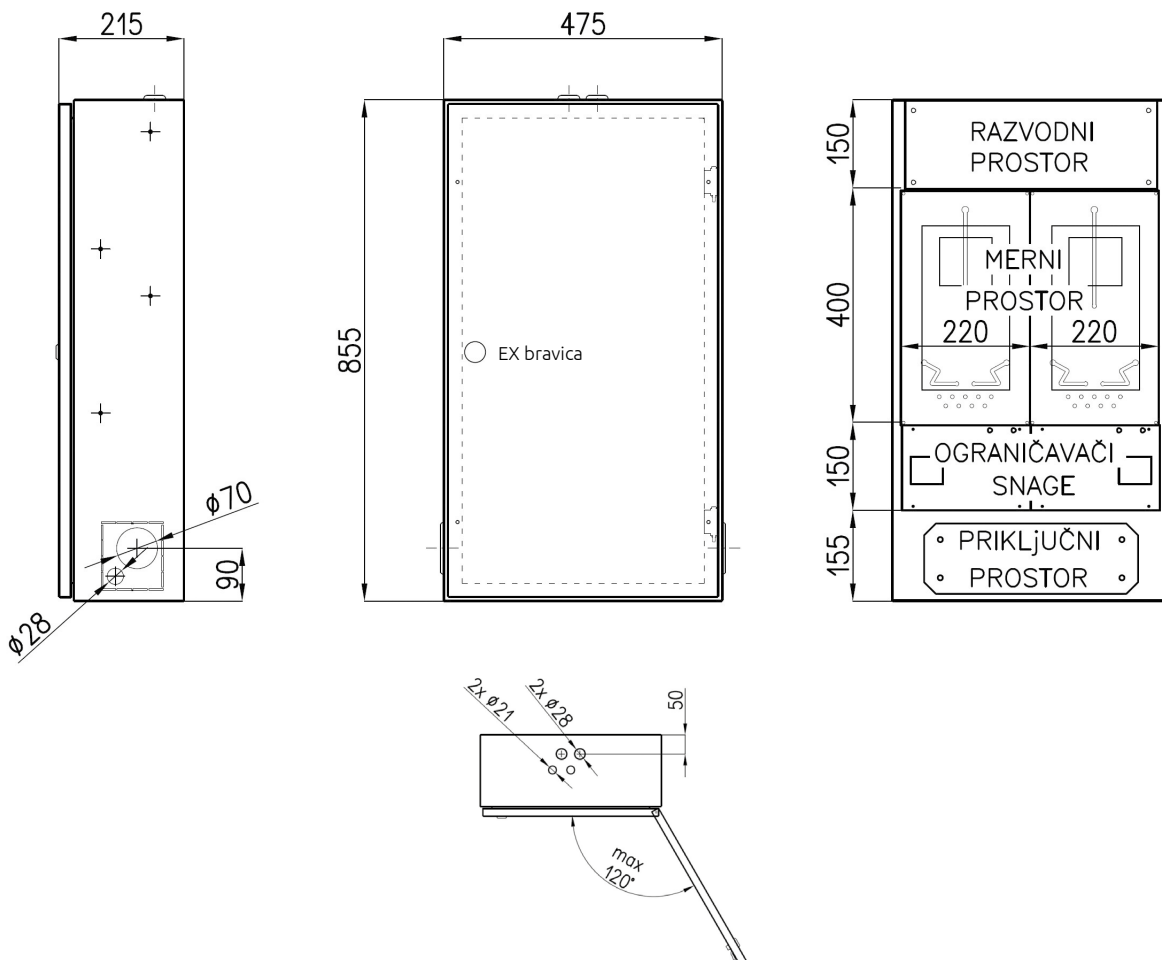



# METALNI MERNI RAZVODNI ORMANI

## DIMENZIJE MRO-A2V



World Registrar Group  
ISO 9001  
ISO 14001  
ISO 45001

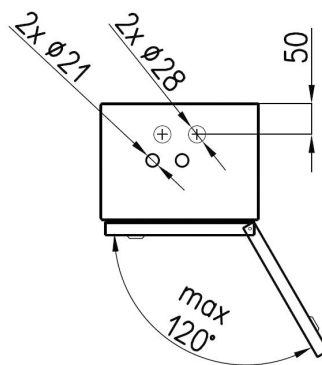
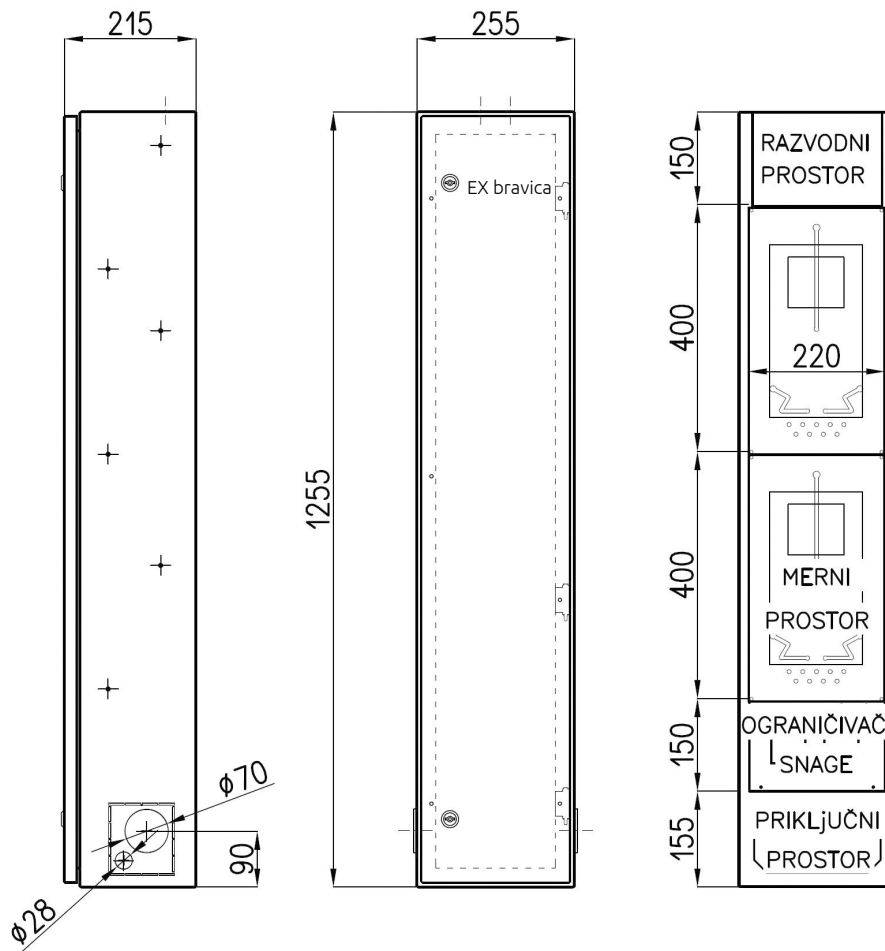

## DIMENZIJE MRO-A1



World Registrar Group  
ISO 9001  
ISO 14001  
ISO 45001

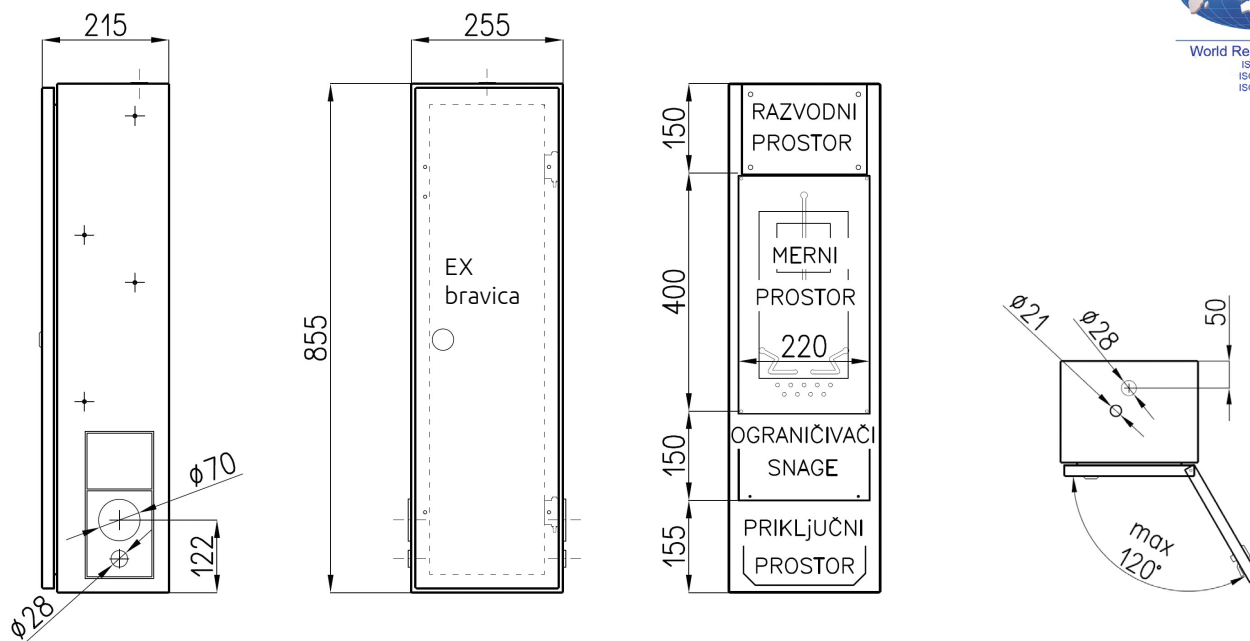

## POSTOLJE

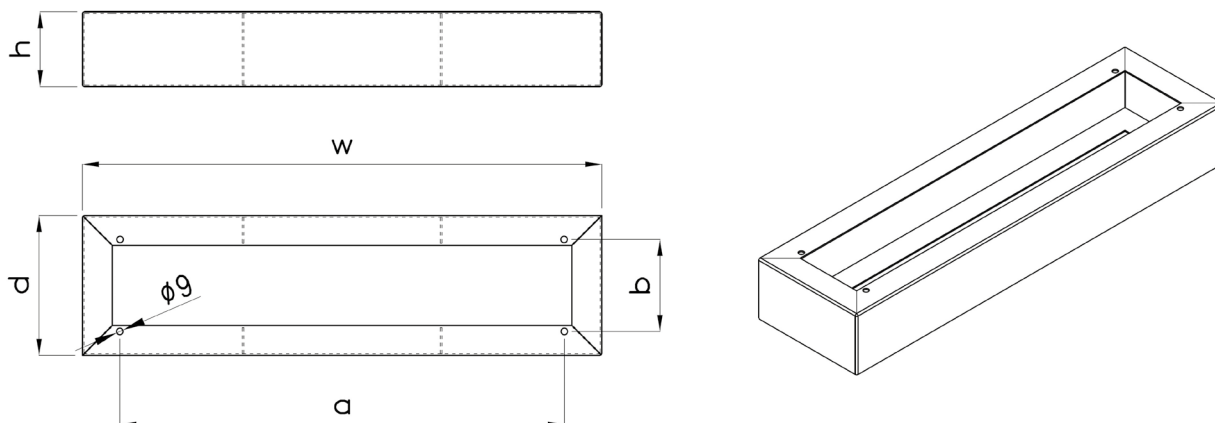

| oznaka postolja | oznaka ormara      | w (mm) | d (mm) | h (mm) | a (mm) | b (mm) | Art. No  |
|-----------------|--------------------|--------|--------|--------|--------|--------|----------|
| CKL-15          | MRO-15 / A15       | 1135   | 187    | 100    | 1035   | 123    | 19-20692 |
| CKL-12          | MRO-12 / A12 / A4H | 915    |        |        | 815    |        | 19-20691 |
| CKL-9           | MRO-9 / A9         | 695    |        |        | 595    |        | 19-20690 |
| CKL-6           | MRO-6 / A6         | 475    |        |        | 375    |        | 19-20689 |
| CKL-4           | MRO-4 / A4         | 475    |        |        | 375    |        | 19-20766 |
| CKL-3           | MRO-3 / A3 / A2V   | 255    |        |        | 155    |        | 19-20767 |
| CKL-2           | MRO-2 / A2         | 475    |        |        | 375    |        | 19-20768 |
| CKL-1           | MRO-1 / A-1        | 255    |        |        | 155    |        | 19-20769 |



World Registrar Group  
ISO 9001  
ISO 14001  
ISO 45001



Tipski ugradni ormani iz serije MOMM ugrađuju se u zid pojedinačno ili linijski u kombinaciji sa ostalim ormanima iz iste serije, sa zatvaranjem bočnih stranica demontažnim čeličnim panelima.. Sastoje se od kućišta, vrata i bočnih pokrivnih panela.

Kućište je izrađeno od dekapiranog hladno valjanog čeličnog lima (DC01) debljine 2.0mm. Rešetkasta konstrukcija rama kućišta ukurucena distantnim profilima spojenim zavarivanjem MAG postupkom. Zadnja stranica potpuno zatvorena sa povijenim krajevima. Otvor za vrata kućišta formiran sa okapnicom visine min 12mm. Na dnu izveden profilisan nosač pleksiglas ploče sa centralnim vijkom M6x25 za montažu.

Unutrašnjost opremljena vijcima M6x25, pobakarisanim, zavarenim elektro-otpornim kontaktnim zavarivanjem koji nose provodnik uzemljenja sa navrtkama i zupčastim podloškama.

Šarniri od renomiranog proizvođača, pocinkovani, skriveno postavljeni vijčanom vezom, demontažni, bez potrebe za naknadnim održavanjem.

Vrata su izrađena od dekapiranog hladno valjanog čeličnog lima (DC01) debljine 2.0mm. Izvedba sa desnim otvaranjem, maksimalnim uglom otvaranja do 120° i sa otvorima za nadleđanje ugrađene elektro opreme. Zabavljivanje sa dve brave i ključem, opciono drugačije zabavljivanje na zahtev naručioca.

Bočne stranice izrađene od dekapiranog hladno valjanog čeličnog lima (DC01), sa 4 vijka M6x16 pobakarisanim, zavarenim elektro-otpornim kontaktnim zavarivanjem, opremljene pocinkovanim navrtkama M6.

Naručivanje odvojeno od ormara, opciono. Gornja ploča izrađena od dekapiranog hladno valjanog čeličnog lima (DC01), sa adekvatnim brojem otvora - uvodnika kablova, Pričvršćuje se vijcima za konstrukciju ormara. Naručivanje odvojeno od ormara, opciono.

Antikorozivna zaštita kućišta i vrata obavljena postupkom pasivnog fosfatiziranja i elektro-statičke plastifikacije strukturnim poliester prahom, UV stabilnim na spoljašnje uslove, pečenjem u peći na temperaturi od 180°C u standardnoj nijansi boje prema RAL 7035 (svetlo siva).





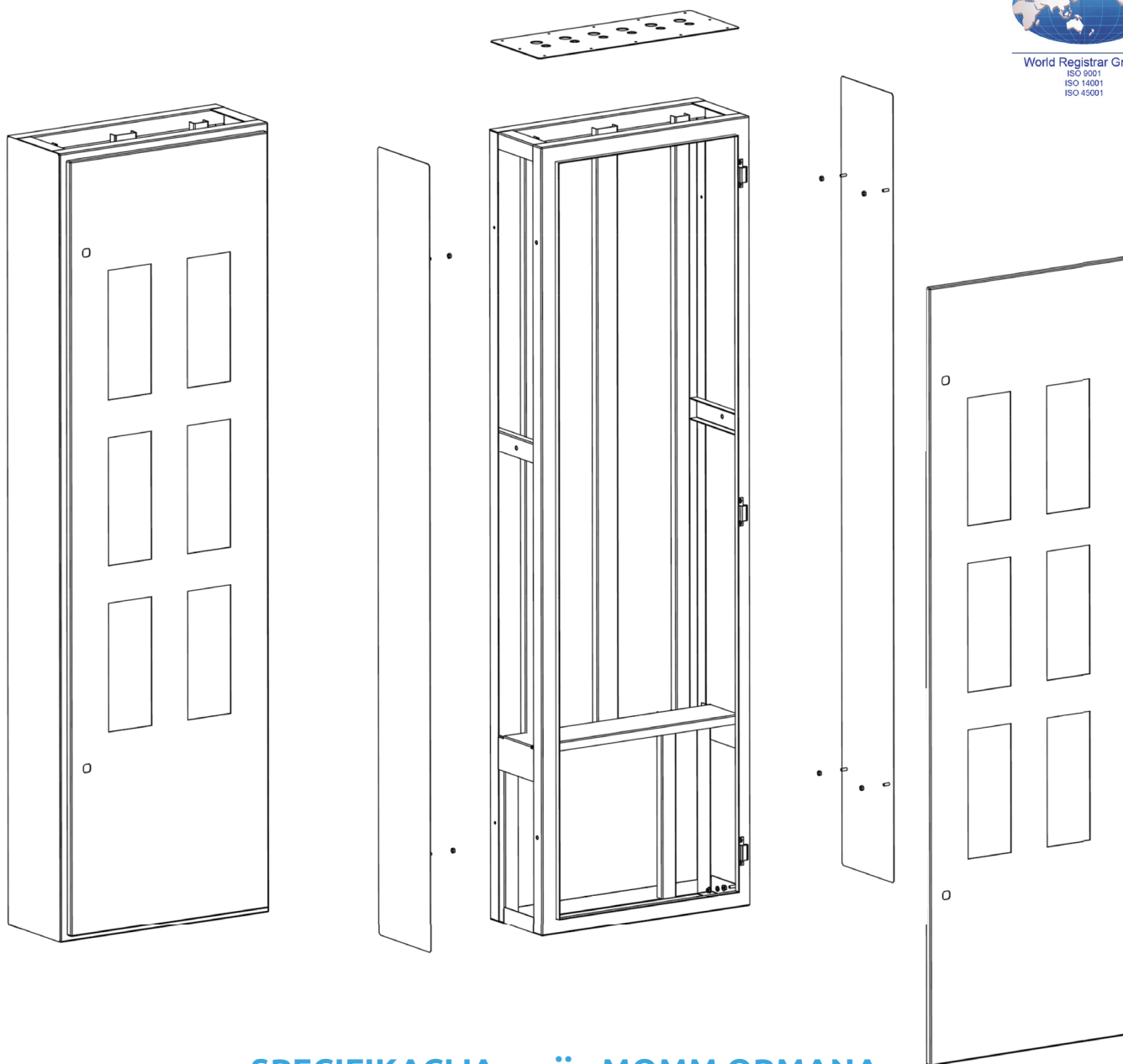

### SPECIFIKACIJA serije MOMM ORMANA

| oznaka ormara         | širina (mm) | visina (mm) | dubina (mm) | broj bravica | broj šarnira | Art. No  |
|-----------------------|-------------|-------------|-------------|--------------|--------------|----------|
| MOMM-9                | 800         | 2000        | 244         | 2            | 6            | 19-19719 |
| MOMM-6                | 580         | 2000        |             | 2            | 3            | 19-19718 |
| MOMM-3                | 360         | 2000        |             | 3            | 19-19717     |          |
| bočne strane set 2kom | 244         | 2000        | 1           | -            | -            | 19-19720 |
| gornja ploča GPM9     | 210         | -           | 780         |              |              |          |
| gornja ploča GPM6     | 210         | -           | 560         |              |              |          |
| gornja ploča GPM3     | 210         | -           | 340         |              |              |          |



World Registrar Group  
ISO 9001  
ISO 14001  
ISO 45001

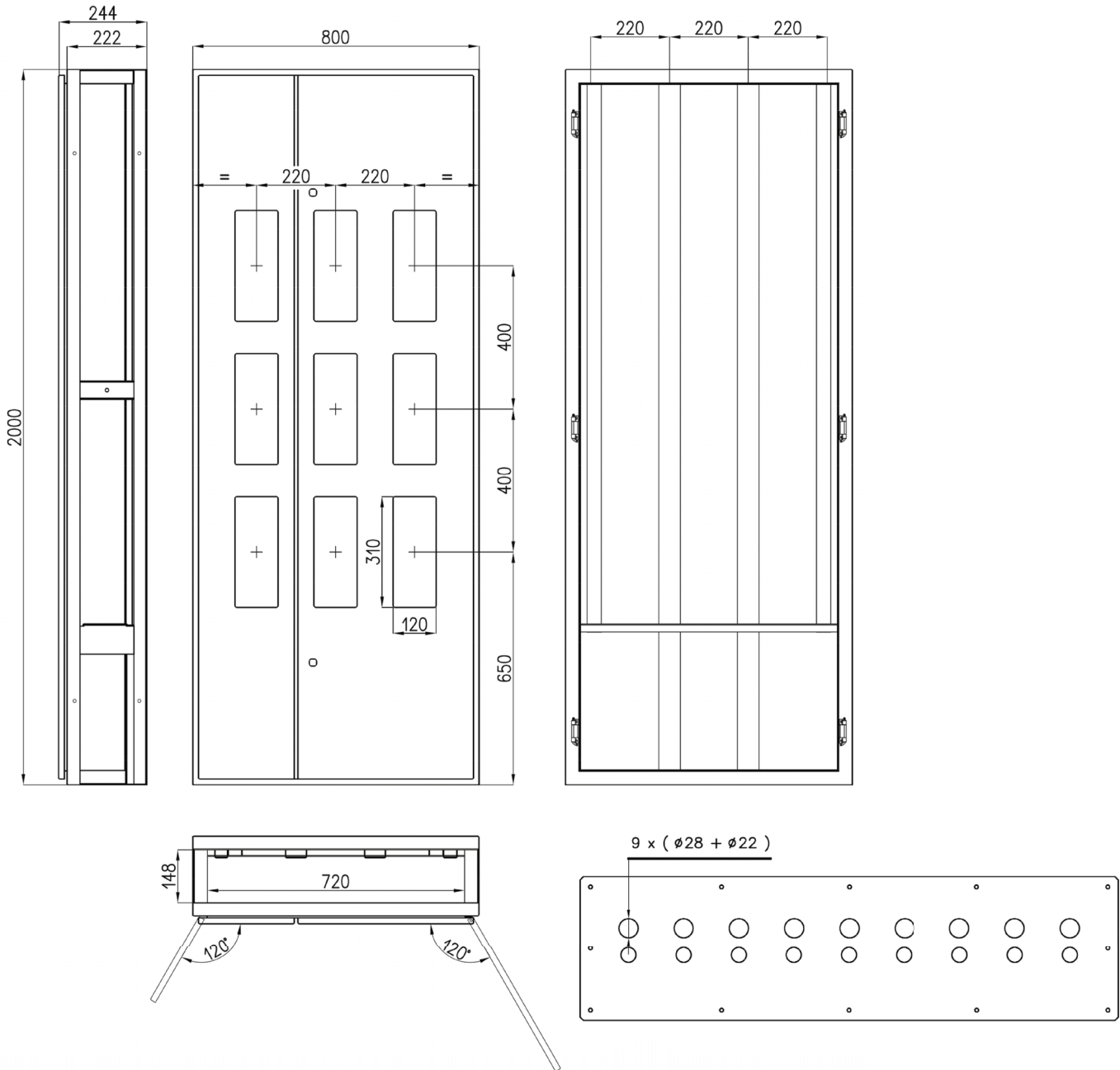

- Gornja ploča sa adekvatnim brojem otvora - uvodnika
- Isporuka opciono, na zahtev.

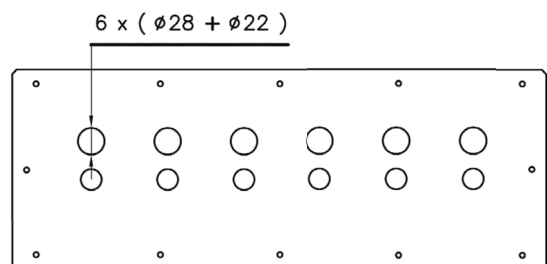
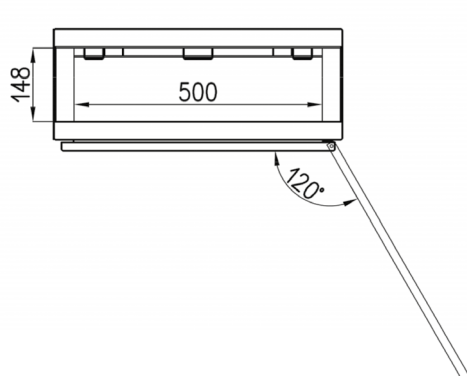
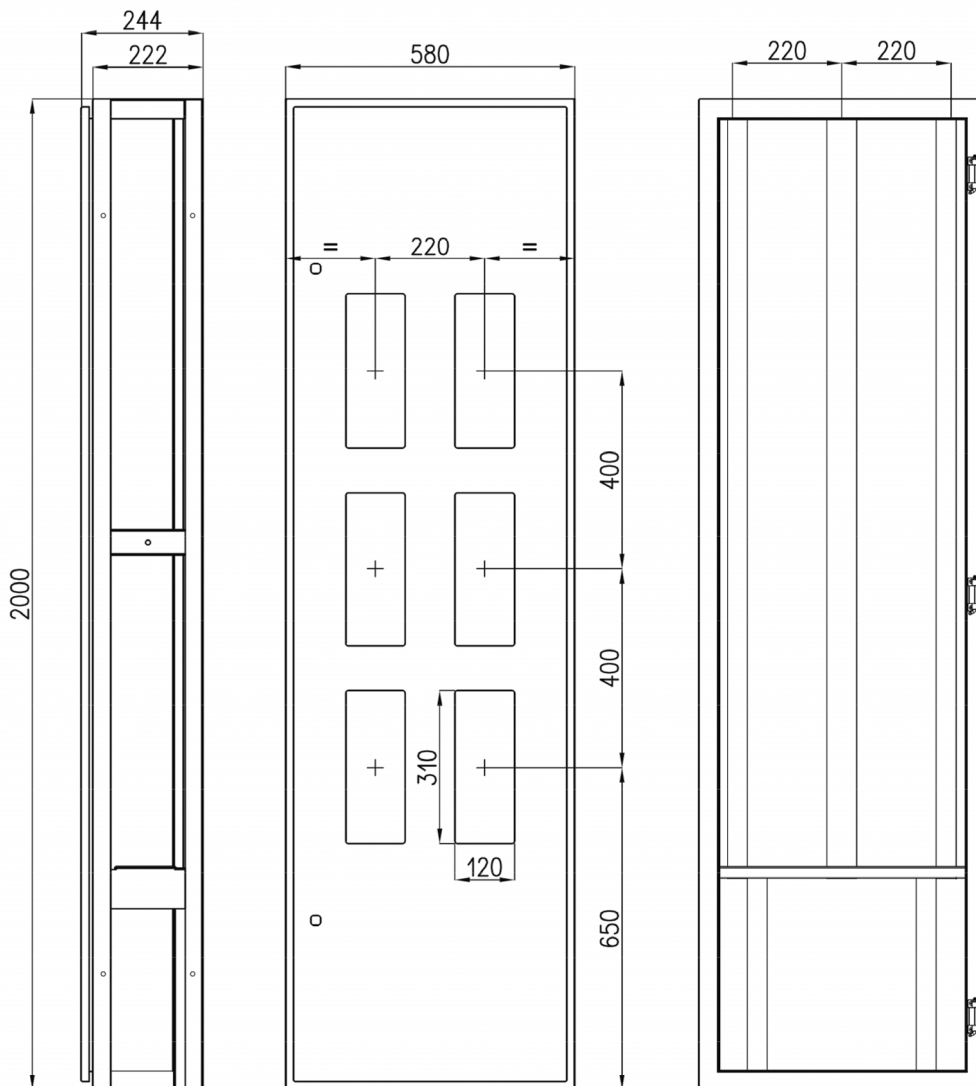

- Gornja ploča sa adekvatnim brojem otvora - uvodnika
- Isporuka opciono, na zahtev.



World Registrar Group  
ISO 9001  
ISO 14001  
ISO 45001

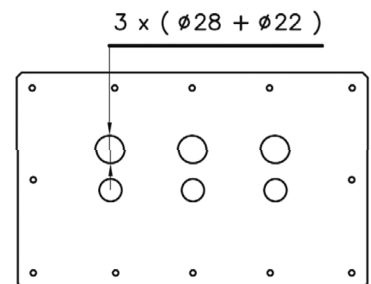
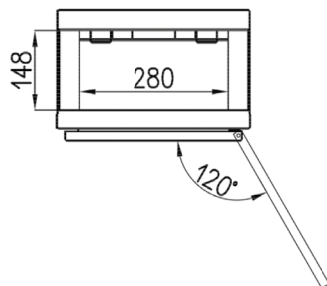
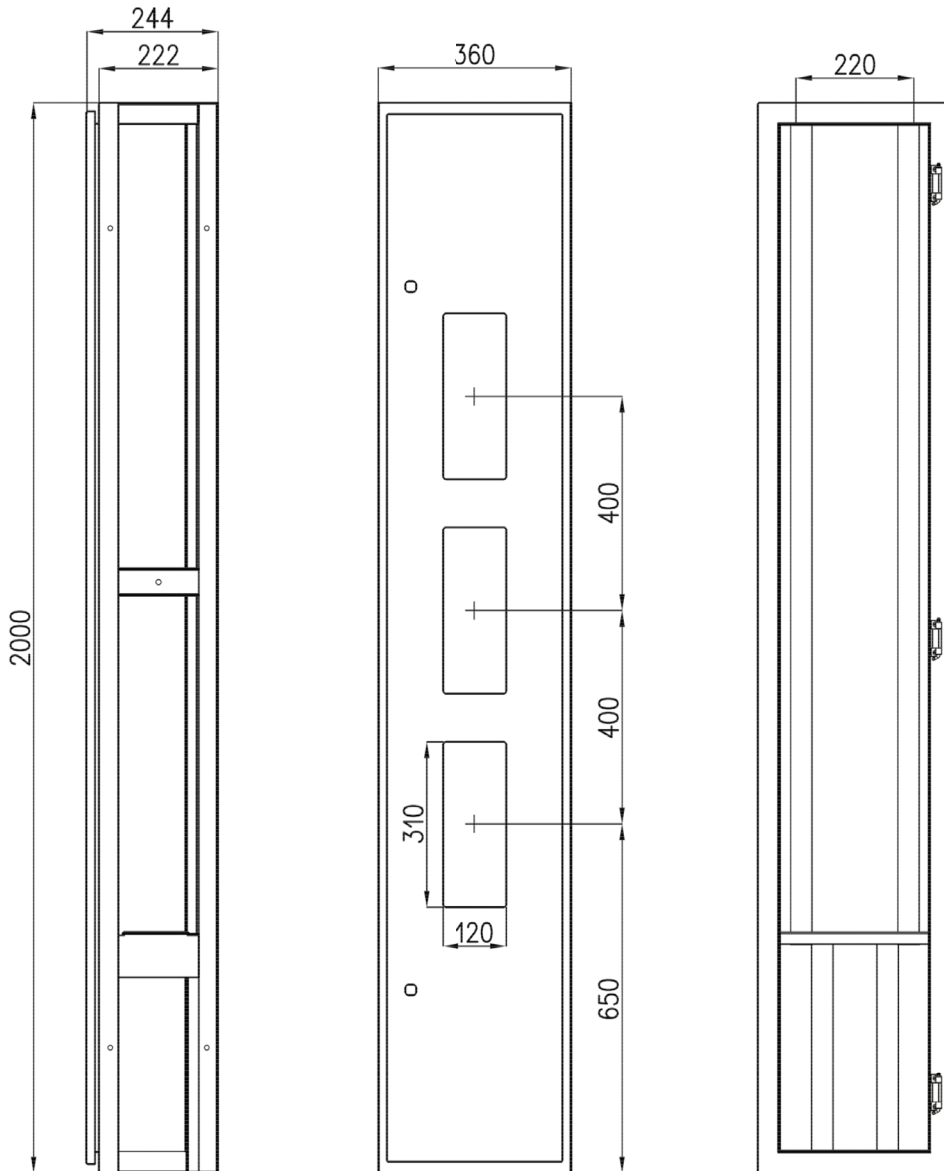

- Gornja ploča sa adekvatnim brojem otvora - uvodnika
- Isporuka opciono, na zahtev.

## METALNI ORMAN ZA INDIREKTNO ILI POLUINDIREKTNO MERENJE BEZ STRUJNIH MERNIH TRANSFORMATORA

### DIMENZIJE MRO-I ORMANA



World Registrar Group  
ISO 9001  
ISO 14001  
ISO 45001

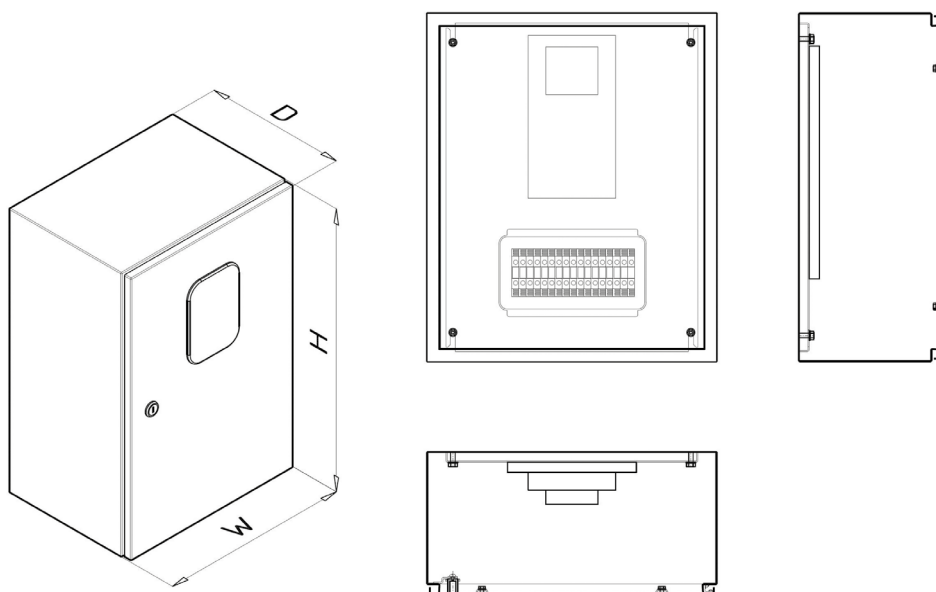

| oznaka<br>ormana | širina<br>W<br>(mm) | visina<br>H<br>(mm) | dubina<br>D (mm) | Art. No  |
|------------------|---------------------|---------------------|------------------|----------|
| MRO-I 506025     | 500                 | 600                 | 250              | 19-20952 |



- Isporučuje se bravicom nadležne EPS distribucije
- Na zahtev može se isporučiti u drugim dimenzijama

# METALNI ORMAN ZA POLUINDIREKTNO MERENJE SA STRUJNIM MERNIM TRANSFORMATORIMA

## DIMENZIJE ORMANA MERNE GRUPE



World Registrar Group  
ISO 9001  
ISO 14001  
ISO 45001

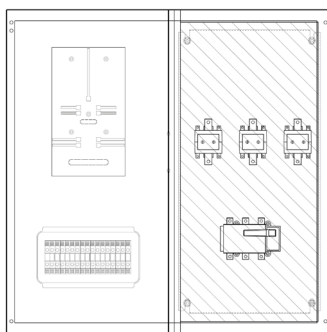
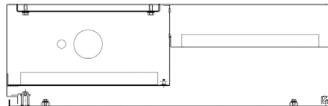
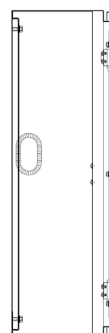
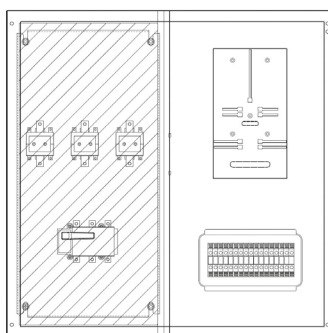
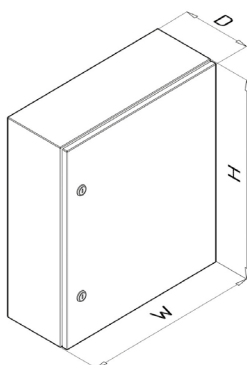

| oznaka ormana  | širina W (mm)    | visina H (mm) | dubina D (mm) | Art. No  |
|----------------|------------------|---------------|---------------|----------|
| MRO-P-L 808025 | 800<br>(400+400) | 800           | 250           | 19-20953 |
| MRO-P-D 808025 | 800<br>(400+400) | 800           | 250           | 19-20954 |



- Isporučuje se bravicom nadležne EPS distribucije
- Na zahtev može se isporučiti u drugim dimenzijama

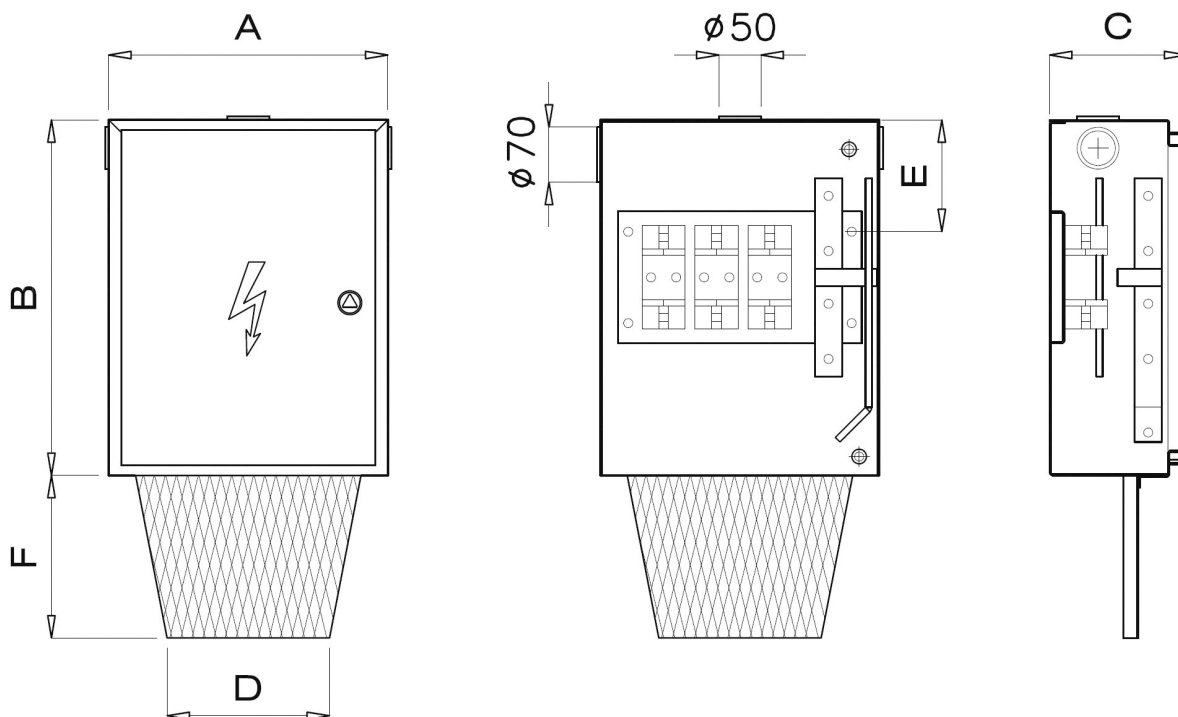

| oznaka ormara | širina A (mm) | visina B (mm) | dubina C (mm) | uvodnik D (mm) | uvodnik F (mm) | E (mm) | Art. No  |
|---------------|---------------|---------------|---------------|----------------|----------------|--------|----------|
| KPK 3x160/--  | 275           | 350           | 130           | 160            | 160            | 100    | SO-20595 |
| KPK 3x250/--  | 400           | 450           | 150           | 160            | 270            | 150    | SO-20955 |
| KPK 3x400/--  | 400           | 600           | 150           | 270            | 270            | 300    | SO-20956 |



- Izrađuje se od hladno valjanog lima
- Antikorozivna zaštita kućišta i vrata obavljena plastifikacijom, pečenjem u standardnoj nijansi boje prema RAL 7035 (svetlo siva).
- Izrađuje se u skladu sa propisima nadležne distribucije